

Basic Connector Dimensions

Most Popular **Standard** Connectors

**Universal
"Fits All"**

OSTW

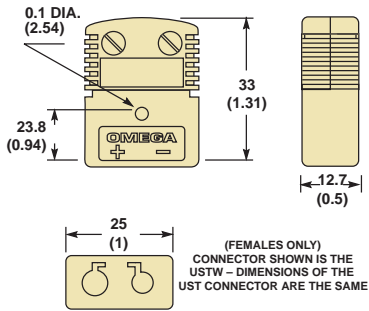

OSTW & HSTW

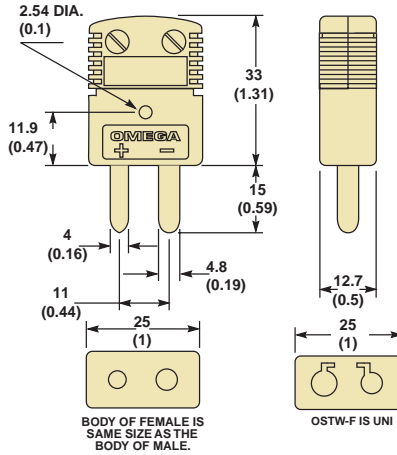

OSTW-CC

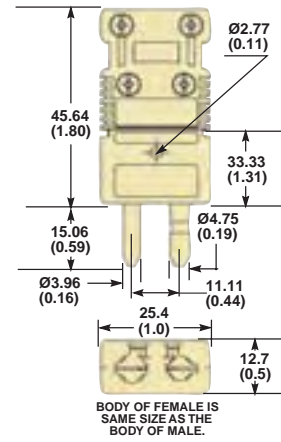

OGP

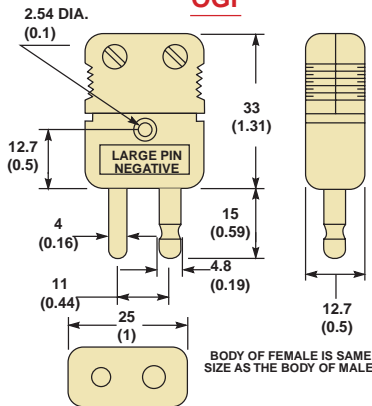

DTC

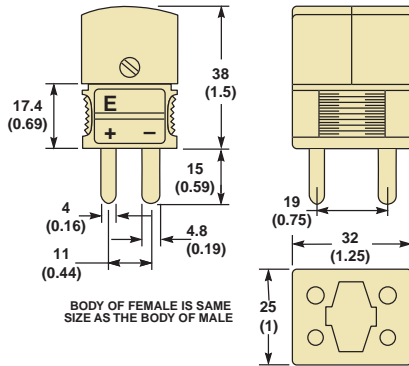

NHX & NHXH

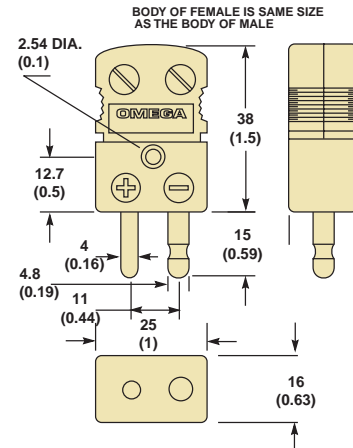

NOX

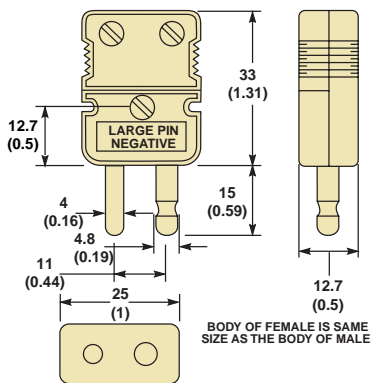

OTP

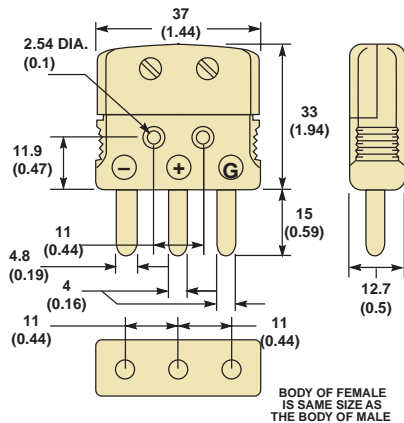

GST (HGST)

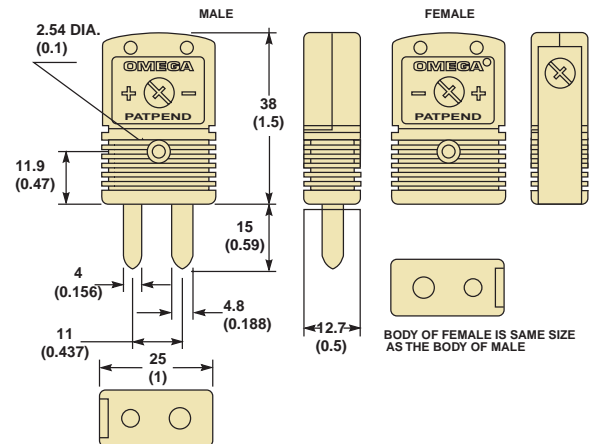

PATENTED

Covered by U.S and
International patents and
pending applications

Dimensions: mm (inches)

Basic Connector Dimensions

Most Popular **Miniature** Connectors and Circuit Board Connectors

PATENTED
Covered by U.S and International patents and pending applications

HMPW, SMPW & SMP

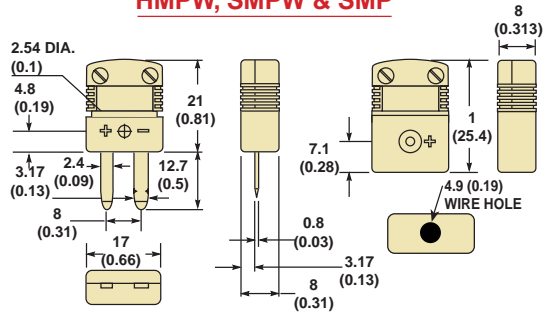

NMP

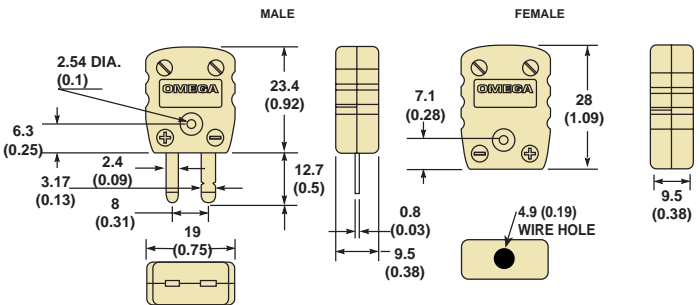

SHX & USHX

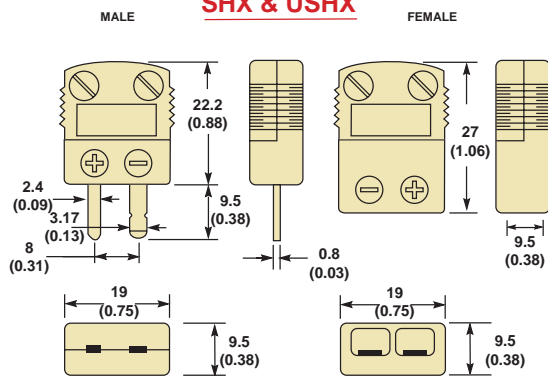

GMP & HGMP

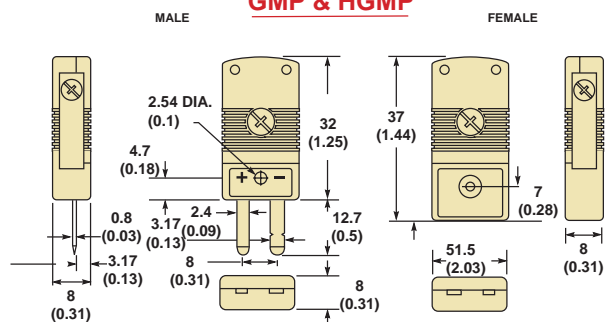

MTP

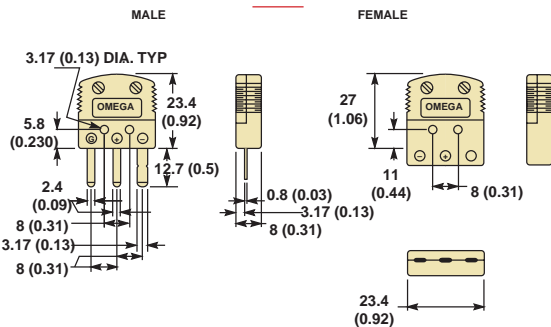

PCC-OST

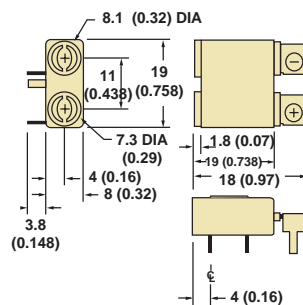

PCC-SMP

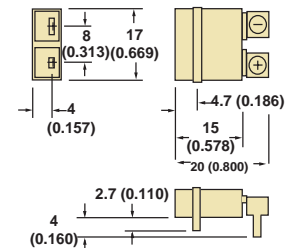

PCC-SMP-V

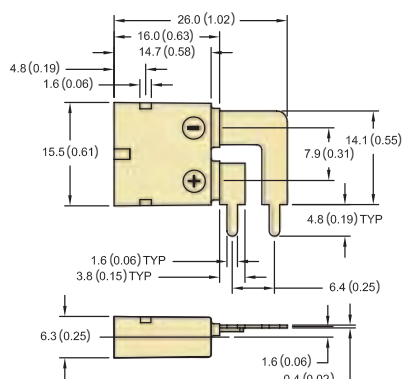

SMPW-CC

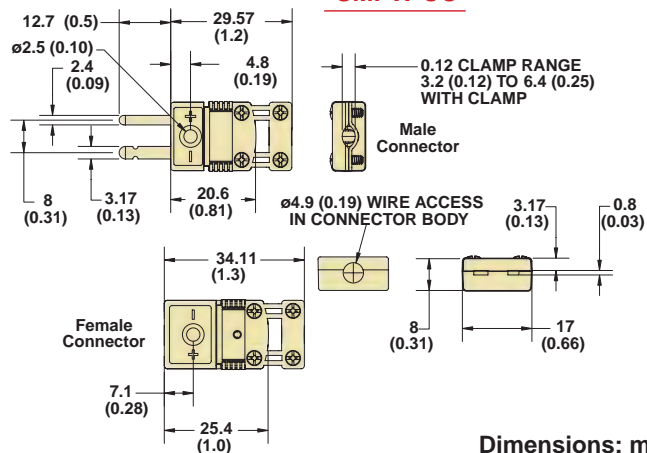

Dimensions: mm (inches)



Basic Connector Dimensions

Most Popular Transition and Panel Connectors

PATENTED
 Covered by U.S and International patents and pending applications

TAS-U-5

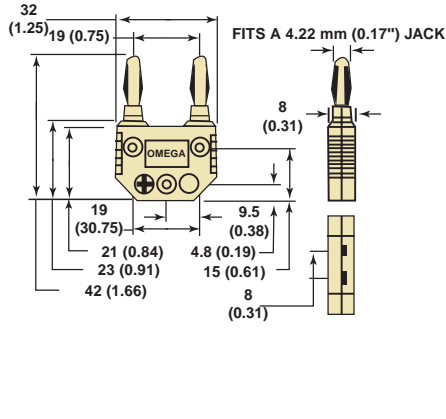

TAS-()-()

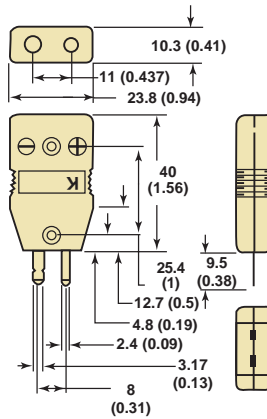

UPJ

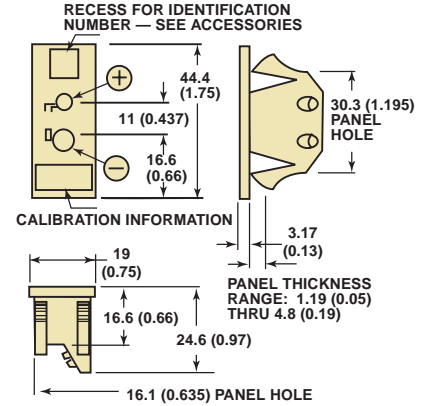

SPJ

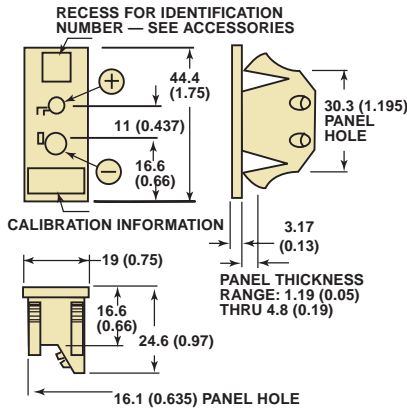

JP

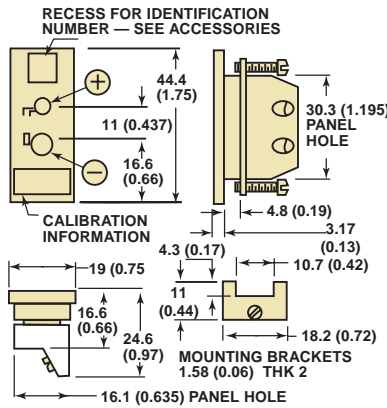

TPJ

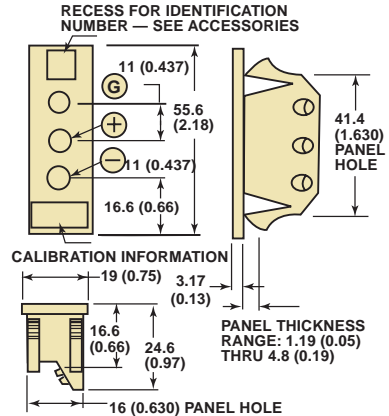

RSJ-() S & R

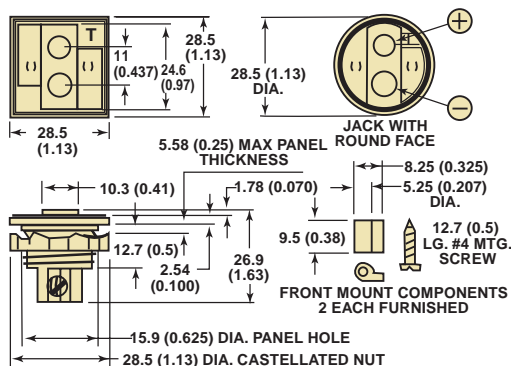

RMJ

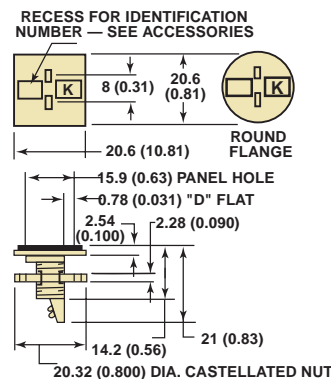

MPJ

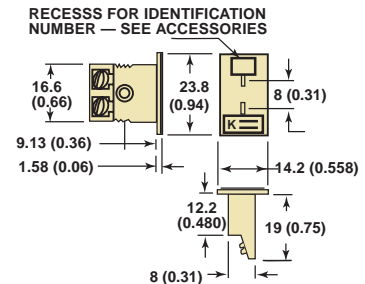

Dimensions: mm (inches)

Basic Connector Dimensions

Most Popular Multipin and Miscellaneous Connectors

PATENTED
Covered by U.S and International patents and pending applications

MTC () FF

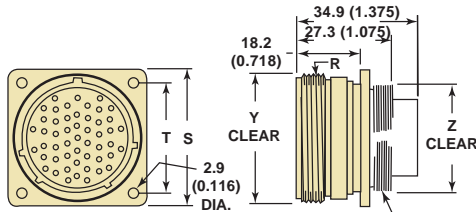

PINS	T	S	Y	Z	M THRD.	R THRD.
5	18.26 (0.72)	23.98 (0.94)	19.05 (0.75)	14.48 (0.57)	0.562-24 UNEF	0.687-24
12	20.62 (0.81)	26.16 (1.03)	23.11 (0.91)	19.30 (0.76)	0.750-20 UNEF	0.875-20
24	24.61 (0.97)	31.75 (1.25)	28.19 (1.11)	24.13 (0.95)	0.937-20 UNEF	1.062-18
41	29.36 (1.16)	36.58 (1.44)	33.78 (1.33)	30.48 (1.20)	1.187-18 UNEF	1.312-18
55	31.75 (1.25)	39.62 (1.56)	36.83 (1.45)	33.53 (1.32)	1.312-18 UNEF	1.437-18

FC & MC

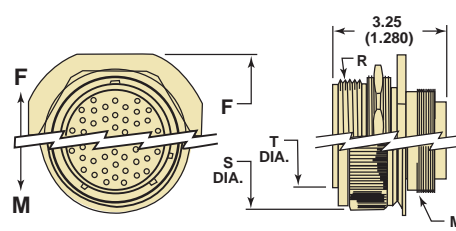

PINS	S	T	F	M THRD	R THRD.
5	21.08 (0.83)	13.46 (0.53)	27.67 (1.09)	0.562-24	0.687-24
12	25.15 (0.99)	17.78 (0.70)	32.77 (1.29)	0.750-20	0.875-20
24	30.23 (1.19)	22.61 (0.89)	38.61 (1.52)	0.937-20	1.062-18
41	36.07 (1.42)	28.45 (1.12)	45.97 (1.81)	1.187-18	1.312-18
55	39.37 (1.55)	31.75 (1.25)	49.53 (1.95)	1.312-18	1.437-18

MTC

MSP

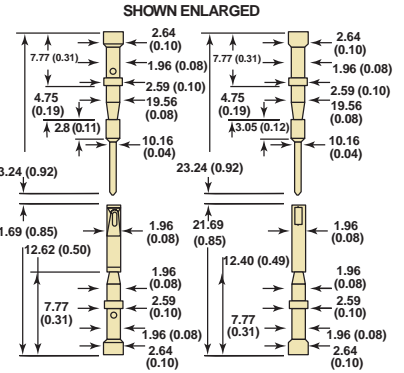

SMTC

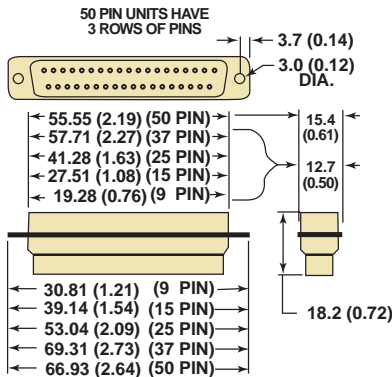

SMTC PINS

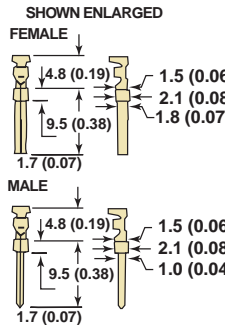

TA () F

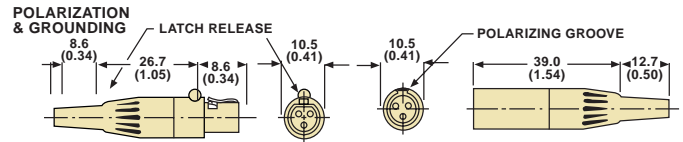

TA () M

TA () FL

TA () ML



ALL DIMENSIONS SAME AS SHOWN ABOVE

BS

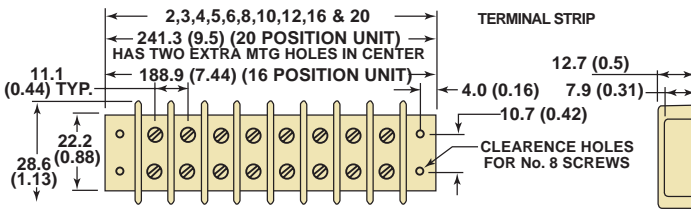

TL

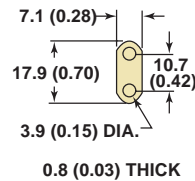

SL

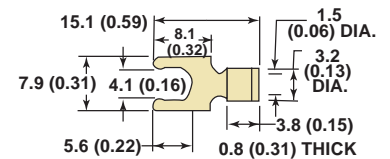

TY

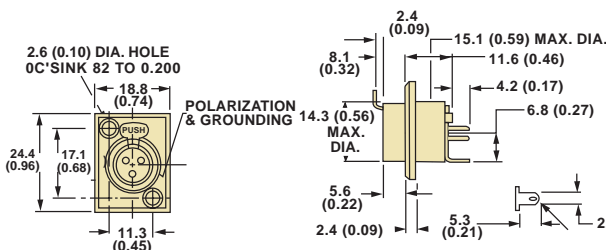

TB

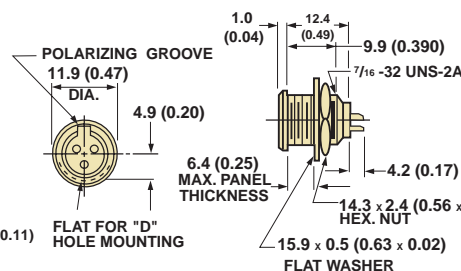

CH62

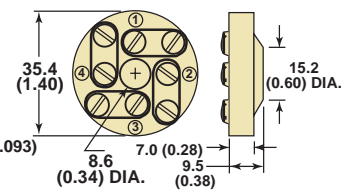

Dimensions: mm (inches)

G

omega.co.uk[®]

Your One-Stop Source for Process Measurement and Control!

Freephone 0800 488 488 | International +44(0) 161 777 6622 | Fax +44(0) 161 777 6622 | Sales@omega.co.uk

www.omega.co.uk



UNITED STATES

www.omega.com

1-800-TC-OMEGA
Stamford, CT.

UNITED KINGDOM

www.omega.co.uk

Manchester, England
0800-488-488
+44-(0)161-777-6611

CANADA

www.omega.ca

Laval(Quebec)
1-800-TC-OMEGA

FRANCE

www.omega.fr

0800-466-342

GERMANY

www.omega.de

Deckenfronn, Germany
0800-8266342

BENELUX

www.omega.nl

0800-099-33-44



More than 100,000 Products Available!

• Temperature

Calibrators, Connectors, General Test and Measurement Instruments, Handheld Instruments for Temperature Measurement, Ice Point References, Indicating Labels, Crayons, Cements and Lacquers, Infrared Temperature Measurement Instruments, Recorders, Relative Humidity Measurement Instruments, PT100 Probes, PT100 Elements, Temperature & Process Meters, Timers and Counters, Temperature and Process Controllers and Power Switching Devices, Thermistor Elements, Probes and Assemblies, Thermocouples, Thermowells and Head and Well Assemblies, Transmitters, Thermocouple Wire, RTD Probes

• Flow and Level

Air Velocity Indicators, Doppler Flowmeters, Level Measurement, Magnetic Flowmeters, Mass Flowmeters, Pitot Tubes, Pumps, Rotameters, Turbine and Paddle Wheel Flowmeters, Ultrasonic Flowmeters, Valves, Variable Area Flowmeters, Vortex Shedding Flowmeters

• pH and Conductivity

Conductivity Instrumentation, Dissolved Oxygen Instrumentation, Environmental Instrumentation, pH Electrodes and Instruments, Water and Soil Analysis Instrumentation

• Data Acquisition

Communication Products and Converters, Data Acquisition and Analysis Software, Data Loggers Plug-in Cards, Signal Conditioners, USB, RS232, RS485, Ethernet and Parallel Port Data Acquisition Systems, Wireless Transmitters and Receivers

• Pressure, Strain and Force

Displacement Transducers, Dynamic Measurement Force Sensors, Instrumentation for Pressure and Strain Measurements, Load Cells, Pressure Gauges, Pressure Reference Section, Pressure Switches, Pressure Transducers, Proximity Transducers, Regulators, Pressure Transmitters, Strain Gauges, Torque Transducers, Valves

• Heaters

Band Heaters, Cartridge Heaters, Circulation Heaters, Comfort Heaters, Controllers, Meters and Switching Devices, Flexible Heaters, General Test and Measurement Instruments, Heater Hook-up Wire, Heating Cable Systems, Immersion Heaters, Process Air and Duct, Heaters, Radiant Heaters, Strip Heaters, Tubular Heaters