

# Two-Colour and Single Colour Handheld Infrared Pyrometers OMEGASCOPE®

OS3750 Series  
Starts at  
**£955**



OS3753 2-colour pyrometer, £1725.



- ✓ Through the Lens Optical System
- ✓ High Temperature Applications
- ✓ Models Available:
  - 2-Colour/1-Colour Wide Range from 400 to 3000°C (752 to 5432°F)
  - Single Colour 300 to 1000°C (572 to 1832°F)
  - Single Colour 600 to 2000°C (1112 to 3632°F)
- ✓ Two Colour Unit Uses Both InGaAs and Si Element Which Reduces Influence of Emissivity and Provide High Sensitivity and High Accuracy Measurement
- ✓ Measured Value Is Digitally Displayed in the Viewfinder and on Front Panel
- ✓ Target Size of 20 mm (0.8") Can be Measured at a Distance of 4 m (13')
- ✓ By Connecting a Type K Surface Thermocouple, You Can Measure Low Temperature Surfaces and Compensate for Emissivity

- ✓ Small Size, 100 H x 148 W x 70 mm D (4 x 6 x 3"), and Light Weight, 350 g (13 oz), Make Long-Term Measurement Easy
- ✓ 500 Readings Can Be Stored and Replayed
- ✓ Maximum, Minimum, and Average Value Math Functions
- ✓ Peak and Hold Readings
- ✓ Optional Software and Cable

## Thermocouple Included!

All models include a free 1 m long (36") Type K insulated beaded wire thermocouple with subminiature connector and wire spool caddy.  
**Order a Spare! Model No. SC-GG-KI-30-1M, £10**



The OS3750 Series is a small, lightweight handheld thermometer with a clear viewfinder. The thru-the-lens optical system enables it to measure small targets from a long distance. The measured value can be read on the internal digital display in the viewfinder. Three models are available. The OS3753 IR Pyrometer combines the functions of a 2-colour and single colour wide range pyrometer in one model. The OS3751 is a single-colour medium temperature range model, and the OS3752 is a single-colour high temperature range model.

The OS3750 Series can be mounted on a tripod or when there is no room for a tripod, on a fixed location by a universal head (sold separately).

## OS3753 Two-Colour Model

The OS3753 allows for measurement to be made by comparing the ratio of 2 different

wavelengths. The advantage of this is by using a ratio, the measurement is independent of emissivity. It is also unaffected by dust or other contaminants in the field of view or by dirt collecting on a viewing window.

### OS3750-SOFT Datalogging Software and OS3750-CABLE

Datalogging software is available for easy data processing by a personal computer. Also available is an RS232, 9-pin cable.

Three kinds of data management modes are available: real-time trend mode, multi-point monitoring mode by utilizing memory, and 1-point historical trend mode. Graph display, report creation, printing, and data storage can be easily executed. The export of the measured data to worksheet applications is also possible.

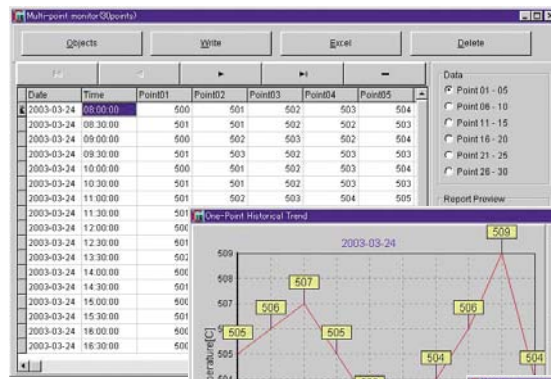

Historical Data and Trend.

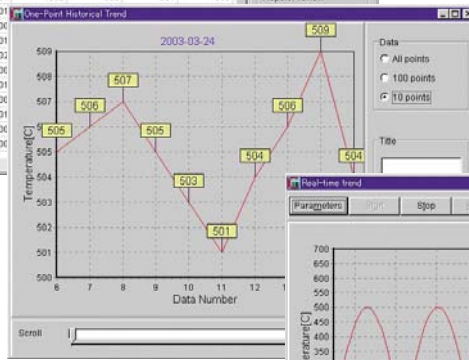

Historical Trend.

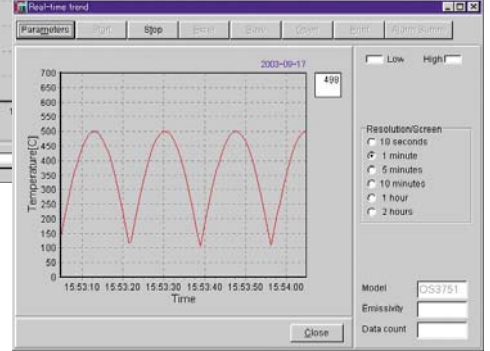

Real Time.

<b>Model No.</b>	<b>OS3750-SOFT</b>
<b>Environment</b>	OS Windows (minimum 10 MB is required to install)
<b>Media</b>	CD-R (2m of RS232C cable with D-Sub 9 pins female connector is attached)
<b>Readout</b>	Readout of transmitted data by RS232C from OS3750 Series
<b>Functions</b>	Display on a personal computer; data storage and replay; printer output
<b>Graphic Display</b>	640 x 480 dots (initial), 1024 x 768 (resized by a personal computer)
<b>Measurement Mode</b>	Real-time trend mode; multi-point monitoring mode, 1-point trend mode

	<b>Real-time Trend</b>	<b>Multi-Point Monitoring (30 points)</b>	<b>1-Point Trend (500 data)</b>
<b>Readout of Data Stored</b>	<ul style="list-style-type: none"> <li>Real-time trend graph (in real-time trend logging mode)</li> <li>Alarm summary</li> </ul>	<ul style="list-style-type: none"> <li>Readout of monitoring data up to 30 point</li> <li>Creation of reports (table, graph)</li> <li>Input of measurement place name and settings of high/low alarms are enabled on each measurement place</li> <li>Grouping each 5-point on table and graph</li> </ul>	<ul style="list-style-type: none"> <li>Readout of continuous data up to 500 data</li> <li>Display by graph</li> <li>Display of all data</li> <li>Display of specified data (100 points/10 points selectable)</li> <li>Maximum, minimum, and average</li> </ul>
<b>Datalogging and Graphic Display</b>	<ul style="list-style-type: none"> <li>Measuring cycle: 0.5 to 10 seconds</li> <li>Chart speed: 10-second, 1-minute, 5-minute, 10-minute, 1-hour, 2-hour screen (6-step selection)</li> <li>Scroll function: chart time axis can be scrolled after measurement stop or reply of data stored</li> <li>Temperature range: auto-range or fixed range is selectable</li> <li>High/low alarms</li> </ul>		
<b>Storage Type</b>	<ul style="list-style-type: none"> <li>File for replay of trend graph</li> </ul>	<ul style="list-style-type: none"> <li>Storage of 30 points data base</li> </ul>	
<b>Export to Excel 97 (*)</b>	<ul style="list-style-type: none"> <li>All data of date, time and temperature on real-time trend</li> <li>Alarm summary</li> </ul>	<ul style="list-style-type: none"> <li>Monitoring data base table up to 30 points</li> </ul>	<ul style="list-style-type: none"> <li>Continuous data up to 500</li> </ul>
<b>Data Stored</b>	<ul style="list-style-type: none"> <li>Maximum 1000 data (maximum memory capacity=600kb)</li> <li>Alarm summary 100 data (renewed to updated data)</li> </ul>	<ul style="list-style-type: none"> <li>Database up to 30 points</li> </ul>	
<b>Printer Output</b>	<ul style="list-style-type: none"> <li>Real-time trend graph</li> <li>Alarm summary report</li> </ul>	<ul style="list-style-type: none"> <li>Table form report</li> <li>Graph form report</li> </ul>	<ul style="list-style-type: none"> <li>Historical trend graph</li> </ul>

\* Requires that Excel 97 has been installed on a personal computer.

**DIAMETER/DISTANCE**

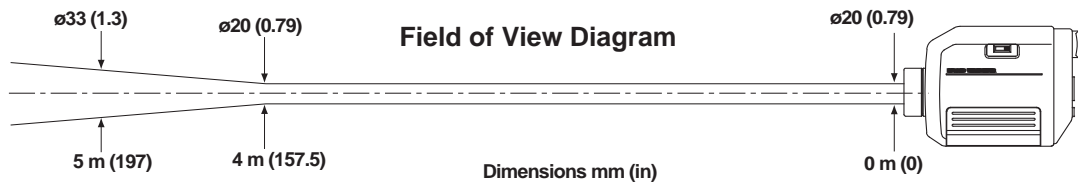

**OUTSIDE DIMENSIONS**

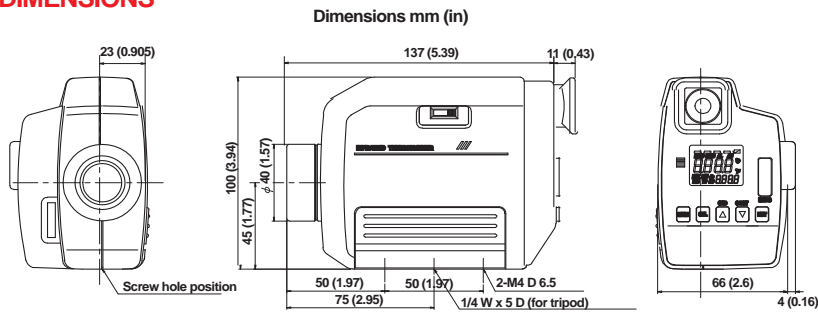

**FUNCTIONS**

**Viewfinder**

Measuring switch

Entry key

Set key

Select key

Memory

DC Power

PC

T/C

Connectors

OMEGASCOPE® OS3753

Ω OMEGA

1000°C

600\*2000°C

110050 DCB

**TYPICAL SURFACE THERMOCOUPLES USED WITH OS SERIES OMEGASCOPE®**

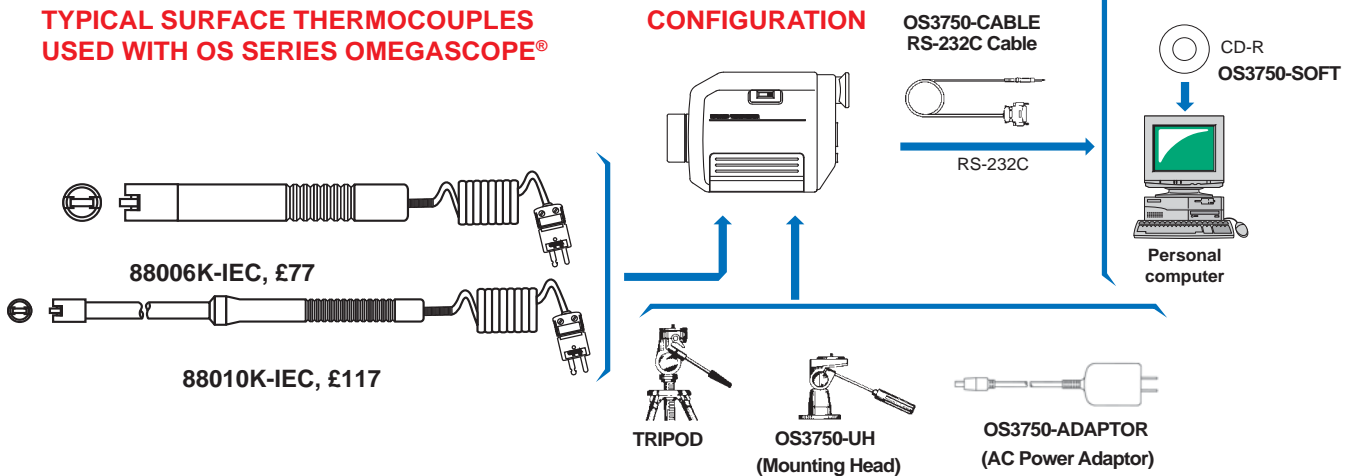

## OMEGASCOPE® Specifications

Types	Single-Colour For Medium Temperature	Single-Colour For High Temperature	Dual Function Type (2-Colour and Single-Colour Wide Range Type)
Model No.	OS3751	OS3752	OS3753
Measuring System	Narrow band radiation thermometer		
Element	InGaAs	Si	Si/InGaAs
Wavelength	1.55 µm	0.9µm	0.9/1.55 µm
Temperature Range	300 to 1000°C (572 to 1832°F)	600 to 2000°C (1112 to 3632°F)	600 to 2000°C (1112-3632°F)(2-colour) 400 to 3000°C (752-5432°F)(single-colour) (key switching)
Accuracy Rating	±6°C (11°F)	Less than 1000°C (1832°F): ±6°C (±10.8°F) 1000 to 1500°C (1832 to 2732°F): ±0.6% of measured value 1500 to 2000°C (2732 to 3632°F): ±1.2% of measured value More than 2000°C (3632°F): ±2.4% of measured value	
Repeatability	within ±1°C (1.8°F)		
Temperature Stability	Temperature drift: 0.2°C/°C (0.36°F/°F)	Temperature drift: less than 1000°C (1832°F): 0.2°C/°C (0.36°F/°F); Over 1000°C (1832°F): 0.02% of measured value/°C or °F	
Resolution	1°C (34°F)		
Response Time	0.25 second (approx 4 seconds: with surface temperature sensor Type K)		
Emissivity Compensation	0.100 to 1.000 (0.001 increment)		
Math	Maximum value, minimum value, average value		
Signal Modulation	Peak, delay		
Display	LCD digital display 4-digit in viewfinder and on front panel		
Data Storage	Maximum 500 data points		
Communications	RS232C (data logging software/OS3750-SOFT)		
Optics	Fixed focus system		
Spot Size	20/4000 mm (0.79/157") (diameter/distance) see field of view diagram		
Targeting	Direct view finder (through the lens)		
Lens Diameter	20 mm Dia. (0.79")		
Thermocouple Input	K thermocouple: -50 to 800°C (-58 to 1427°F) Accuracy: ±2°C (±3.6°F) at 23 ±5°C (±9°F)		
Other Functions	Automatic power-off, automatic backlight display, continuous measurement °C/°F selection, battery check, high/low alarms		
Working Temperature	0 to 50°C (32 to 122°F)		
Software and Cable	Optional		
Power	2 "AA" batteries included (50 hrs at continuous operation) AC power adaptor OS3750-ADAPTOR (sold separately)		
Case Material/Colour	ABS resin/gray		
Outside Dimensions/Weight	100 H x 148 W x 70 mm D (4 x 6 x 3"), about 350 g (13 oz) (thermometer only)		

### ALL MODELS AVAILABLE FOR FAST DELIVERY!

#### To Order (Specify Model Number)

Model No.	Price	Description
OS3751	£1090	Single-colour IR 300 to 1000°C
OS3752	955	Single-colour IR 600 to 2000°C
OS3753	1725	Dual 2-colour/single colour wide range IR pyrometer

Comes with wrist strap, 2 "AA" alkaline batteries, 1 Type K insulated beaded wire thermocouple, and complete operator's manual. **Note:** NIST-traceable calibration with 3 data points is available by adding suffix "-NIST" and £469 to price.

**Ordering Example:** OS3753, dual 2-colour/single colour wide range IR pyrometer, OS3750-SOFT, software and cable, OS3750-ADAPTOR, AC adaptor, and TRIPOD, tripod for mounting, £1725 + 117 + 26 + 30 = £1898.



#### Accessories RECOMMENDED ACCESSORIES HIGHLIGHTED!

Model No.	Price	Description
SC-530	£43.50	Soft case with shoulder strap
OS3750-SOFT	117	Software and cable
OS3750-CABLE	33.50	RS232, 9-pin cable (spare)
OS3750-ADAPTOR	26	100 to 240 Vac power
OS3750-UH	191	Universal mounting head
TRIPOD	30	Tripod for mounting
SC-GG-KI-30-1M	10	1m long Type K beaded wire, spare
MN1500	1.15	"AA" Alkaline battery (2-pack), spare
MN1500-L	4.60	"AA" Lithium battery (2-pack), spare
EE-2454	107	Reference Book: Industrial Electronics Handbook 

#### Type K Surface Probes\* for Contact Surface Measurement

Model No.	Price	Description
88006K-IEC	£77	Miniature surface probe, 480°C (900°F)
88016K-IEC	107	Miniature right-angle surface probe, 480°C (900°F)
88003K-IEC	80	Surface probe, 480°C (900°F)
88101K-IEC	77	Right-angle surface probe, 480°C (900°F)
88010K-IEC	117	High temperature surface probe, 760°C (1400°F)
88107K-IEC	134	Right-angle high temperature surface probe, 760°C (1400°F)

\* See Section A for additional surface probes.





#### UNITED STATES

[www.omega.com](http://www.omega.com)

1-800-TC-OMEGA

Stamford, CT.

#### CANADA

[www.omega.ca](http://www.omega.ca)

Laval(Quebec)

1-800-TC-OMEGA

#### GERMANY

[www.omega.de](http://www.omega.de)

Deckenpfronn, Germany

0800-8266342

#### UNITED KINGDOM

[www.omega.co.uk](http://www.omega.co.uk)

Manchester, England

0800-488-488

#### FRANCE

[www.omega.fr](http://www.omega.fr)

088-466-342

#### CZECH REPUBLIC

[www.omegaeng.cz](http://www.omegaeng.cz)

Karviná, Czech Republic

596-311-899

#### BENELUX

[www.omega.nl](http://www.omega.nl)

0800-099-33-44



## More than 100,000 Products Available!

### • Temperature

Calibrators, Connectors, General Test and Measurement Instruments, Handheld Instruments for Temperature Measurement, Ice Point References, Indicating Labels, Crayons, Cements and Lacquers, Infrared Temperature Measurement Instruments, Recorders, Relative Humidity Measurement Instruments, PT100 Probes, PT100 Elements, Temperature & Process Meters, Timers and Counters, Temperature and Process Controllers and Power Switching Devices, Thermistor Elements, Probes and Assemblies, Thermocouples, Thermowells and Head and Well Assemblies, Transmitters, Thermocouple Wire, RTD Probes

### • Flow and Level

Air Velocity Indicators, Doppler Flowmeters, Level Measurement, Magnetic Flowmeters, Mass Flowmeters, Pitot Tubes, Pumps, Rotameters, Turbine and Paddle Wheel Flowmeters, Ultrasonic Flowmeters, Valves, Variable Area Flowmeters, Vortex Shedding Flowmeters

### • pH and Conductivity

Conductivity Instrumentation, Dissolved Oxygen Instrumentation, Environmental Instrumentation, pH Electrodes and Instruments, Water and Soil Analysis Instrumentation

### • Data Acquisition

Auto-Dialers and Alarm Monitoring Systems, Communication Products and Converters, Data Acquisition and Analysis Software, Data Loggers Plug-in Cards, Signal Conditioners, USB, RS232, RS485 and Parallel Port Data Acquisition Systems, Wireless Transmitters and Receivers

### • Pressure, Strain and Force

Displacement Transducers, Dynamic Measurement Force Sensors, Instrumentation for Pressure and Strain Measurements, Load Cells, Pressure Gauges, Pressure Reference Section, Pressure Switches, Pressure Transducers, Proximity Transducers, Regulators, Pressure Transmitters, Strain Gauges, Torque Transducers, Valves

### • Heaters

Band Heaters, Cartridge Heaters, Circulation Heaters, Comfort Heaters, Controllers, Meters and Switching Devices, Flexible Heaters, General Test and Measurement Instruments, Heater Hook-up Wire, Heating Cable Systems, Immersion Heaters, Process Air and Duct, Heaters, Radiant Heaters, Strip Heaters, Tubular Heaters